

Public Notice #1



State of Rhode Island and Providence Plantations
Coastal Resources Management Council
Oliver H. Stedman Government Center
4808 Tower Hill Road, Suite 3
Wakefield, RI 02879-1900

(401) 783-3370
Fax (401) 783-2069

PUBLIC NOTICE

File Number: 2018-12-037 Date: January 2, 2019

This office has under consideration the application of:

Jon Janikies
166 Waterway
Saunderstown, RI 02874

for a State of Rhode Island Assent to construct and maintain: a residential boating facility consisting of a ~4' x 82' fixed timber pier, a ~4' x 30' access ramp and a 7.5' x 20' (150sf) terminal float. The facility is proposed ~114' in length, extending ~75' seaward of the cited MLW mark. This design requires a 25' length variance to RICRMP Section 1.3.1(D) and also proposes a 10,000lb boat lift and a float lift.

Project Location:	166 Waterway Drive
City/Town:	Narragansett
Plat/Lot:	N-B / 1
Waterway:	Narragansett Bay, West Passage

Plans of the proposed work may be seen at the CRMC office in Wakefield.

In accordance with the Administrative Procedures Act (Chapter 42-35 of the Rhode Island General Laws) you may request a hearing on this matter.

You are advised that if you have good reason to enter protests against the proposed work it is your privilege to do so. It is expected that objectors will review the application and plans thoroughly, visit site of proposed work if necessary, to familiarize themselves with the conditions and cite what law or laws, if any, would in their opinion be violated by the work proposed.

If you desire to protest, you must attend the scheduled hearing and give sworn testimony. A notice of the time and place of such hearing will be furnished you as soon as possible after receipt of your request for hearing. If you desire to request a hearing, to receive consideration, it should be in writing (**with your correct mailing address, e-mail address and valid contact number**) and be received at this office on or before February 2, 2019.

/lat

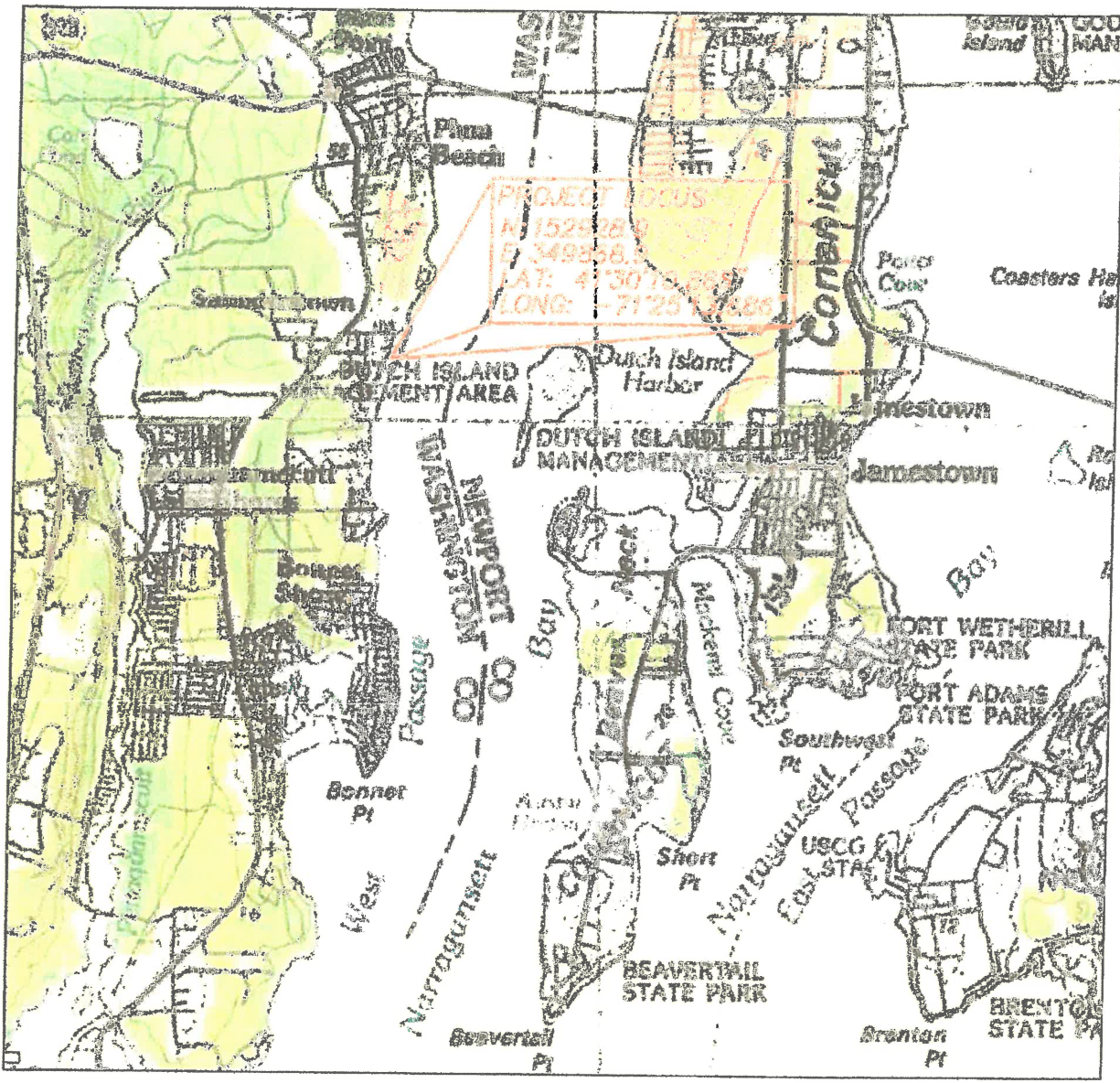

LOCUS PLAN
1"=5280'

PROPOSED RESIDENTIAL PIER FOR:
 JONATHAN JANIKIES
 166 WATERWAY
 NARRAGANSETT AP NB, LOT 1
 NORTH KINGSTOWN, AP 1, LOT 148
 BY: WARREN HALL, CIVIL ENGINEER
 DEC 3, 2018 SHEET 1 OF 10

RECEIVED
 DEC 13 2018
 COASTAL RESOURCES
 MANAGEMENT COUNCIL

WARREN HALL

 REGISTERED
 PROFESSIONAL ENGINEER

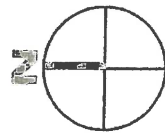
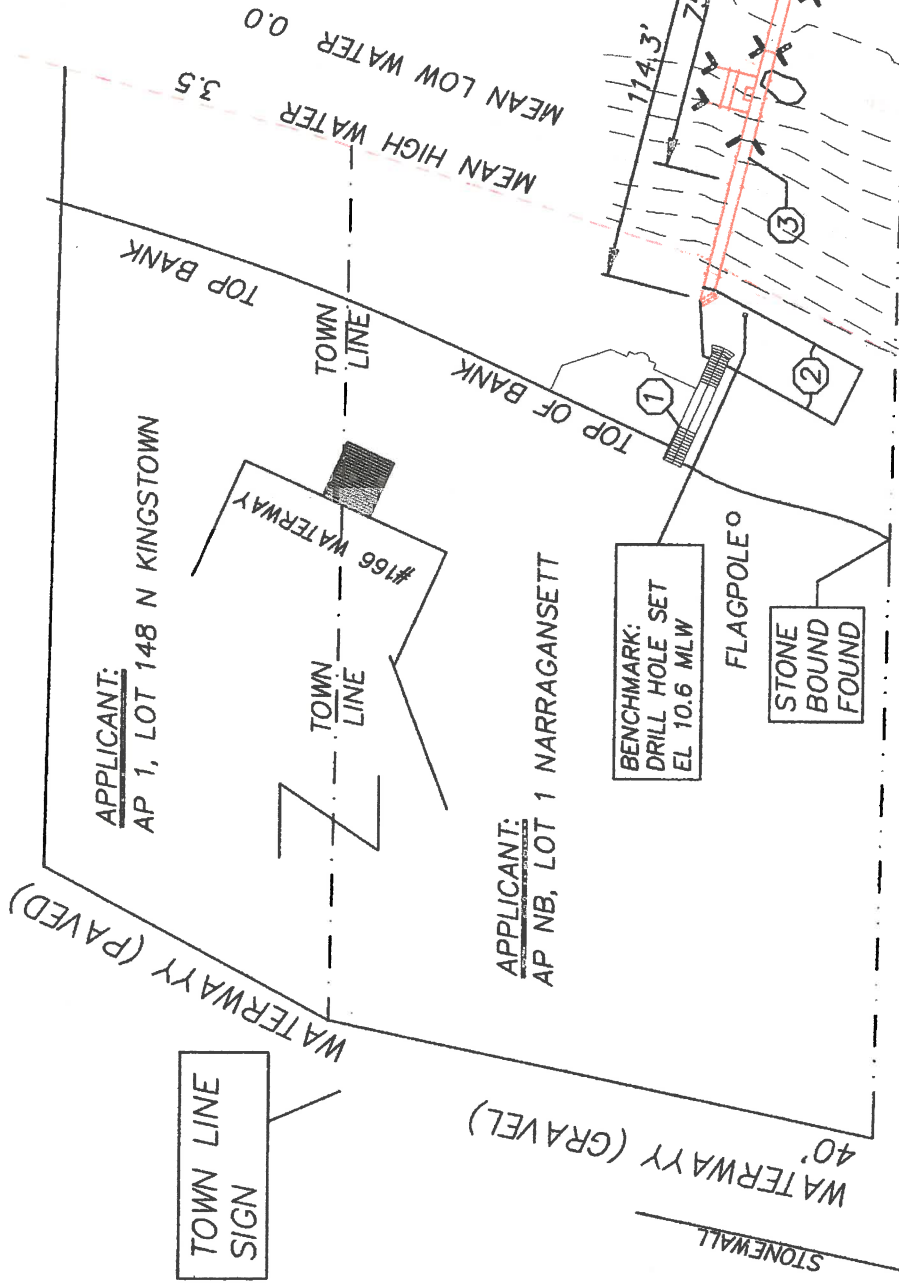
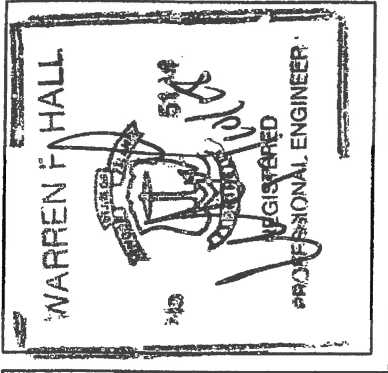

- ① EXISTING STEPS
- ② EXISTING CONCRETE DECK
- ③ PROPOSED DOCK

PROPOSED RESIDENTIAL PIER FOR:
 JONATHAN JANIKIES
 166 WATERWAY
 NARRAGANSETT AP NB, LOT 1
 NORTH KINGSTOWN, AP 1, LOT 148
 BY: WARREN HALL, CIVIL ENGINEER
 DEC 3, 2018 SHEET 2 OF 10

SEE CRMC FILE 2009-06-048 FOR BUFFER ZONE REQUIREMENTS



RI STATE PLANE COORDINATES

①	N: 152928.9 E: 349868.9
②	N: 152912.5 E: 349977.5
③	N: 152893.1 E: 349972.7

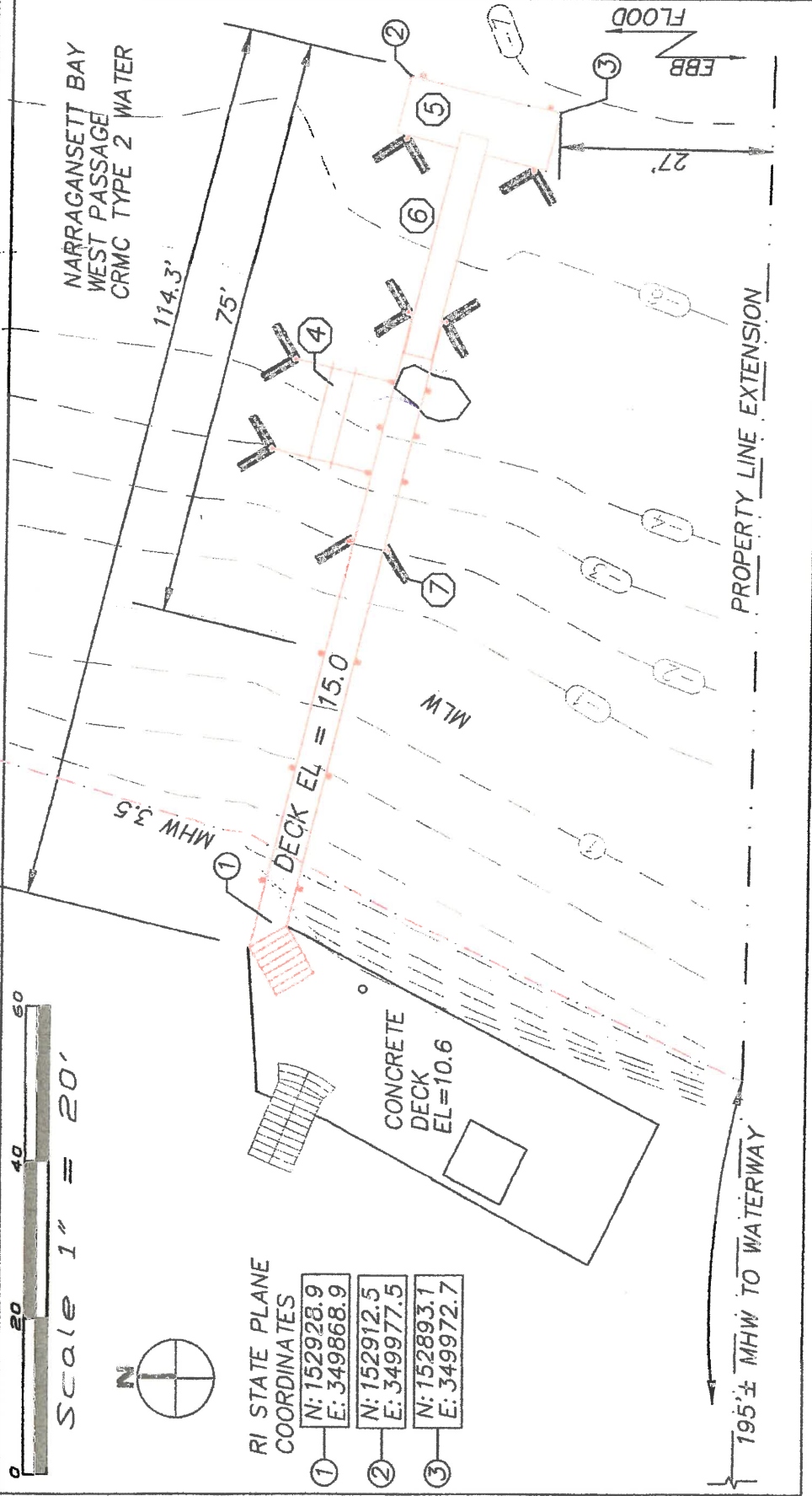

PROPOSED RESIDENTIAL PIER FOR:
 JONATHAN JANIKIES
 166 WATERWAY
 NARRAGANSETT AP NB, LOT 1
 NORTH KINGSTOWN, AP 1, LOT 148
 BY: WARREN HALL, CIVIL ENGINEER
 APPROVED, 2018 SHEET 3 OF 10

- ④ 10,000# BOAT LIFT
- ⑤ 8'x18.75' FLOAT WITH 4 MOTOR LIFT
- ⑥ 3.75'x31' RAMP
- ⑦ BATTER PILES

WARREN F. HALL

REGISTERED PROFESSIONAL ENGINEER

DEC 13 2018
 COSTAL ENGINEERING
 1000 STATE ST. SUITE 200
 PROVIDENCE, RI 02902

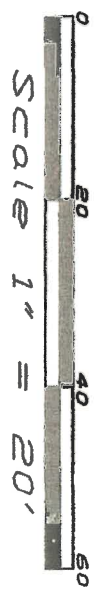
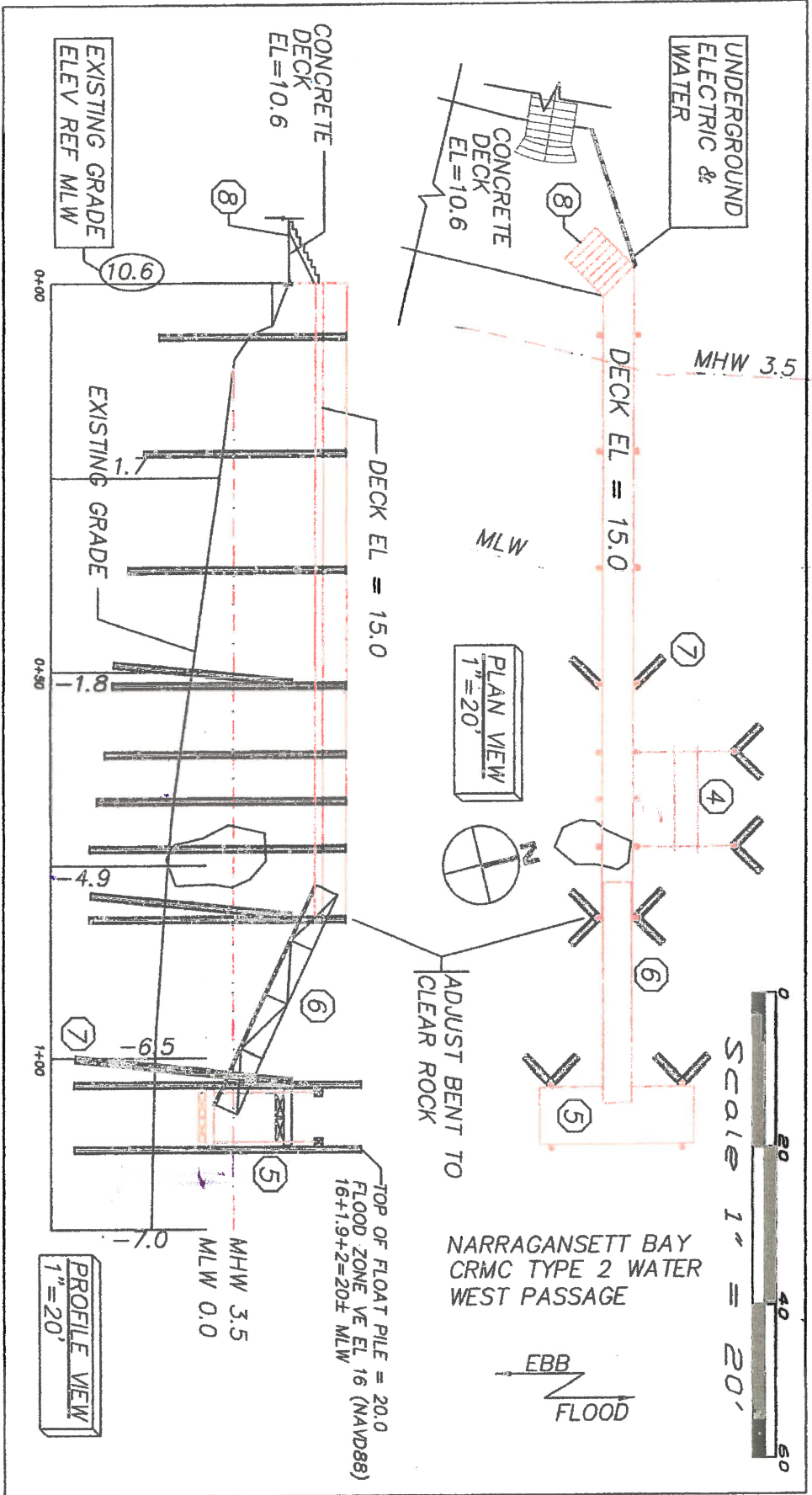

NARRAGANSETT BAY
CRMC TYPE 2 WATER
WEST PASSAGE

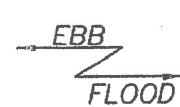

PROPOSED RESIDENTIAL PIER FOR:
 JONATHAN JANIKIES
 166 WATERWAY
 NARRAGANSETT AP NB, LOT 1
 NORTH KINGSTOWN, AP 1, LOT 148
 BY: WARREN HALL, CIVIL ENGINEER
 DEC. 3, 2018 SHEET 4 OF 10

- ④ 10,000# BOAT LIFT
- ⑤ 8'x18.75' FLOAT WITH 4 MOTOR LIFT
- ⑥ 3.75'x31' RAMP
- ⑦ BATTER PILES
- ⑧ 3@3x12 STRINGER FASTEN TO DECK WITH SIMPSON ANCHORS

WARREN HALL
 REGISTERED PROFESSIONAL ENGINEER
 166 WATERWAY
 NORTH KINGSTOWN, RI 02881
 401-846-1111

CRMC Mailing List for JonJanikies
CRMC File Number 2018-12-037

Jon Janikies
166 Waterway
Saunderstown, RI 02874

Estate of Francis Bayard Rhein
c/o Mrs Francis Bayard Rhein
190 Waterway
Saunderstown, RI 02874

Patricia A. Zangari
164 Waterway
Saunderstown, RI 02874

CRMC (2018-12-037)
O. S. Government Center
4808 Tower Hill Road
Wakefield, RI 02879

Warren Hall, PE
63 Elmwood Avenue
Middletown, RI 02842

From: Lisa Turner <lturner@crmc.ri.gov>
Sent: Wednesday, January 02, 2019 3:22 PM
To: Alison Kates, NRPA Program Coordinator; Amy Rose Weinreich, Charlestown TC; 'Andrew Nota, Jamestown Town Administrator'; 'Bruce Eastman, RISA'; 'C. Brown, DBEngineers'; Carol Wordell Little Compton TC; 'Charlotte Taylor'; Cheryl Fernstrom, Jamestown TC; 'Chris Church, Reporter'; 'Christine Andrews, QDC'; Colin Howard, Independent RI -- South Kingstown; Dale Holberton South Kingstown TC; David Latham; 'David Murdock'; David Prescott, Save the Bay; 'Deborah Mongeau, Librarian'; 'Dennis Erkan, RIDEM F&W'; Donna Giordano, Westerly TC; 'Emilie Holland'; 'Eric Schneider, RIDEM Fish and Wildlife'; Glenn Modica; James Bessette, Editorial Assistant; Jean Bellm, Exec Asst, Barrington; Jeanne Spencer, Tiverton Town Clerk's Office; Jeannette Alyward, North Kingstown TC; 'Jeffrey Gardner'; Jennifer M. West, Portsmouth TC; Jerry Elmer, Esq, CLF; 'John Torgan'; 'John Williams, Warwick Cove Marina'; 'Jonathan F. Stone, Exec Dir'; 'Jude Zeh'; Julie Coelho Warren TC; Kathy & Steve Jacques; Kathy & Steve Jacques; 'Kendra L. Beaver, Esq, Save the Bay'; Kim A. Casci-Palangio, East Prov CC; Laura C. Swistak, City Clerk, Newport; 'Lawrence Taft, Exec Dir'; Leigh Carney, Town Clerk; Liz Boardman; Lori Hagen, Prov City Clerk; Louis P. Cirillo, Bristol Town Clerk; Lyn Pagliarini, Warwick City Clerk; Maria Wall Cranston TC; 'Matt Gineo, Oldport Marine'; Matt O'Brien, AP Reporter; Matthew Enright, Independent RI -- Narragansett; Meg Kerr, Audubon Society of RI; Melanie Jewett Army, AICP, RIDOT; Meredith J. DeSisto, Barrington TC; 'Michael McGiveney'; Mike Jarbeau, Save The Bay; Nancy Mello, Tiverton TC; 'Neal Personeus, RIDEM'; Nick Donadio; 'Peter A. Healey'; 'Peter M. Vieira, Marine Construction'; Phil Capaldi; Richard Goldstein Pawtucket TC; 'Richard Kalunian'; 'Robert Lyons, Ocean House Marina'; Rodman R. Black Jr. HIIA; 'Scott Briggs, Librarian'; Taylor Bell (Taylor.M.Bell@usace.army.mil); 'Thomas R. Evans, State Librarian'; 'tim rockwell'; 'Tom Kutcher STB Bay Keeper'; Wendy J. W. Marshall, Middletown TC; Anne Irons, Narragansett TC; Anthony Santilli, Narragansett Building Official; Bryan Couture; Donald Greco; Harvey Cataldo, Bluff Hill Cove Oysters; James Manni, Narr Town Manager; Janice McClanaghan; Jeffrey Ceasrine, PE, Narr Town Engineer; Jill Sabo, AICP, CFM, Town of Narragansett; Michael DiCicco, Director, Narr Public Works; Michael McElroy, Esq.; Michael Vendetti, Chair, BSFD; Narragansett Conservation Commission; Narragansett Times; Patricia Roosa, Narragansett Town Mgrs. Office; Robert Patterson, Narragansett; Scott M. Partington, Fire Chief, Narragansett Fire Dept.; Steve Wright, Narragansett Parks and Recreation; Susan Cicciline-Buonanno, President, Narr Town Council; Thomas J. Dunn Jr., Artisan Builders; Trudy McKendry, HIIA, Secretary; William Onosko
Subject: CRMC Public Notice -- Narragansett
Attachments: 2018-12-037 Janikies Narr.pdf; 2018-11-092 SantaBarbara Narr.pdf

Note: Comments must be received by February 2, 2019

Lisa A. Turner

Office Manager

Coastal Resources Management Council

O S Government Center

4808 Tower Hill Road, Rm 116

Wakefield, RI 02879

(401)783-3370

 **This email is sent on 100% Unused Paper**
Help promote Green Business practices by not printing this email



Narragansett, RI



Home

Search

Print

Previous

Next

Disclaimer: This information is for tax assessing purposes and is not warranted

Parcel Identification

Map/Lot N-B-3
 Account 3355
 State Code 1013
 Card 1/1

Assessment

Land \$1,235,600
 Building \$302,800
 Card Total \$1,538,400
 Parcel Total \$1,538,400

Prior Assessments

Fiscal Year	Land Value	Building Value	Outbuilding Value	Total Value
2018	\$1,235,600	\$297,800	\$5,000	\$1,538,400
2017	\$1,248,100	\$256,400	\$3,800	\$1,508,300
2016	\$1,248,100	\$256,400	\$3,800	\$1,508,300
2015	\$1,248,100	\$256,400	\$3,800	\$1,508,300



Location and Owner

Location 190 WATER WAY
 Owner RHEIN, FRANCIS BAYARD EST OF
 Owner2 C/O MRS. FRANCIS BAYARD RHEIN
 Owner3
 Address 190 WATERWAY
 Address2
 Address3 SAUNDERSTOWN RI 02874

Building Information

D
Y
F
F
E
E
A

S
C
C
C

was notified
- see mailing list
- been receiving calls
• letters from Peter Rheim

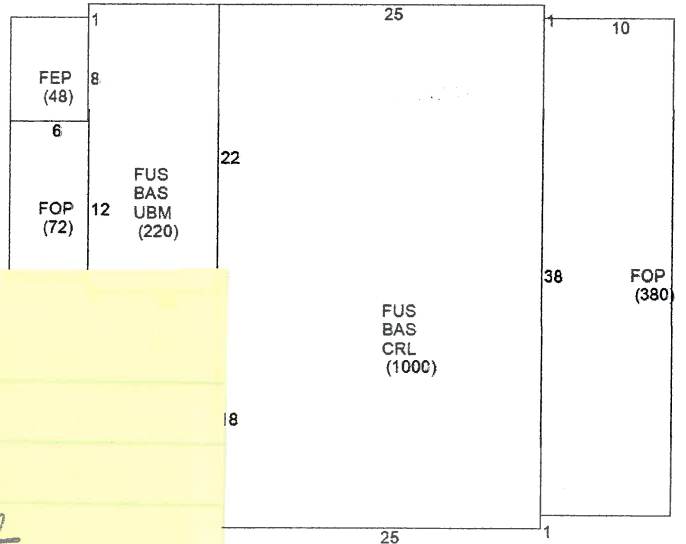

Building Sub Areas

Net Area
220 SF
1,000 SF
1,220 SF
48 SF
452 SF
1,220 SF

Porch, Enclosed, Finished
 Porch, Open, Finished
 Upper Story, Finished

Land Information



State of Rhode Island and Providence Plantations
Coastal Resources Management Council
 Oliver H. Stedman Government Center
 4808 Tower Hill Road, Suite 3
 Wakefield, RI 02879-1900

(401) 783-3370
 Fax (401) 783-2069

PUBLIC NOTICE

File Number: 2018-12-037 Date: January 2, 2019

This office has under consideration the application of:

Jon Janikies
 166 Waterway
 Saunderstown, RI 02874

for a State of Rhode Island Assent to construct and maintain: a residential boating facility consisting of a ~4' x 82' fixed timber pier, a ~4' x 30' access ramp and a 7.5' x 20' (150sf) terminal float. The facility is proposed ~114' in length, extending ~75' seaward of the cited MLW mark. This design requires a 25' length variance to RICRMP Section 1.3.1(D) and also proposes a 10,000lb boat lift and a float lift.

Project Location:	166 Waterway Drive
City/Town:	Narragansett
Plat/Lot:	N-B / 1
Waterway:	Narragansett Bay, West Passage

Plans of the proposed work may be seen at the CRMC office in Wakefield.

In accordance with the Administrative Procedures Act (Chapter 42-35 of the Rhode Island General Laws) you may request a hearing on this matter.

You are advised that if you have good reason to enter protests against the proposed work it is your privilege to do so. It is expected that objectors will review the application and plans thoroughly, visit site of proposed work if necessary, to familiarize themselves with the conditions and cite what law or laws, if any, would in their opinion be violated by the work proposed.

If you desire to protest, you must attend the scheduled hearing and give sworn testimony. A notice of the time and place of such hearing will be furnished you as soon as possible after receipt of your request for hearing. If you desire to request a hearing, to receive consideration, it should be in writing (**with your correct mailing address, e-mail address and valid contact number**) and be received at this office on or before February 2, 2019.

/lat

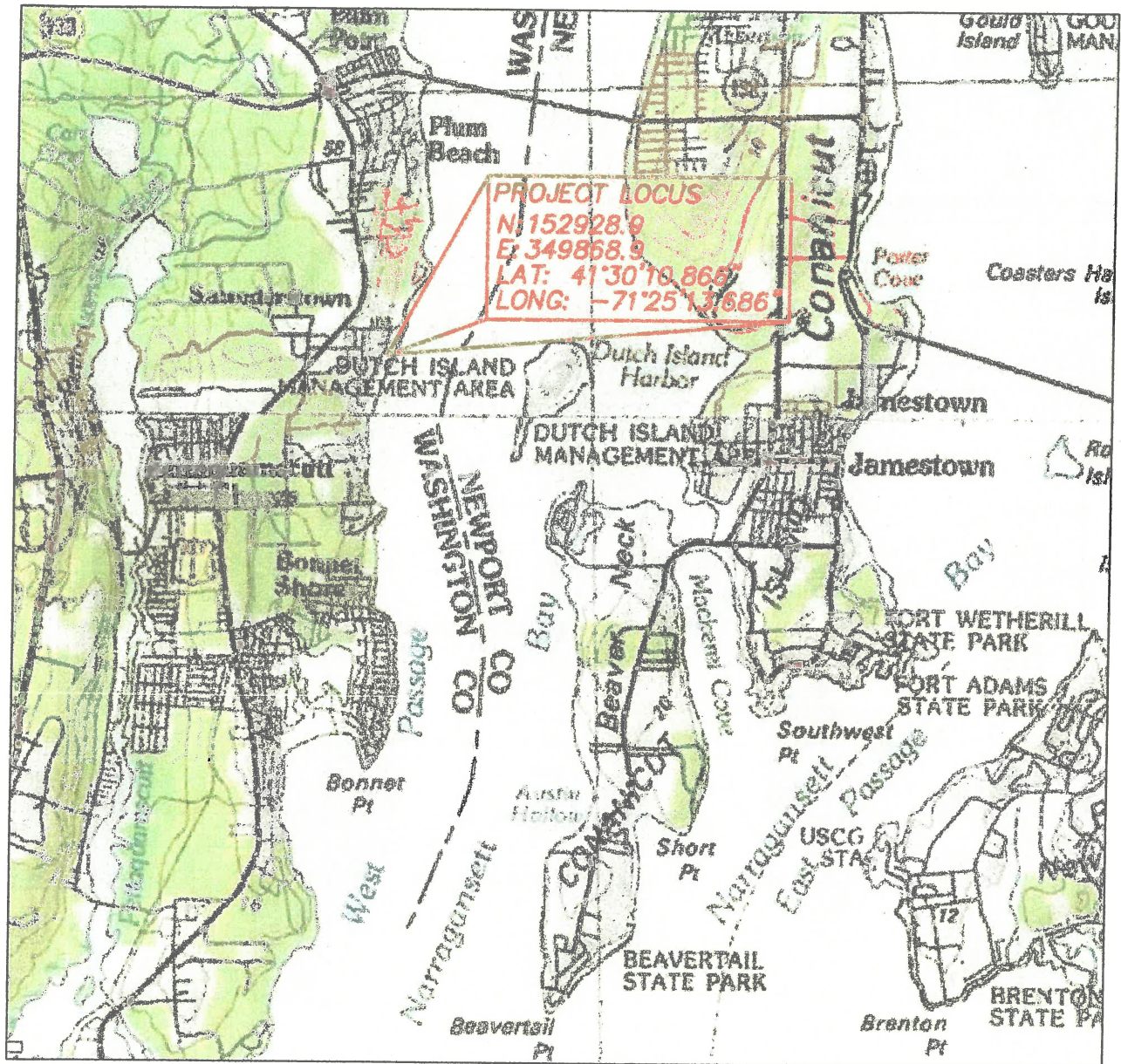

LOCUS PLAN

1"=5280'

PROPOSED RESIDENTIAL PIER FOR:
 JONATHAN JANIKIES
 166 WATERWAY
 NARRAGANSETT AP NB, LOT 1
 NORTH KINGSTOWN, AP 1, LOT 148
 BY: WARREN HALL, CIVIL ENGINEER
 DEC 3, 2018 SHEET 1 OF 10

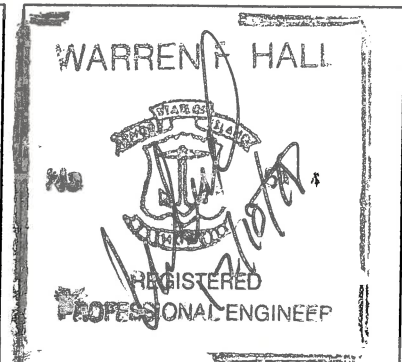
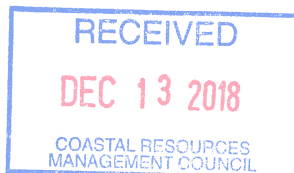

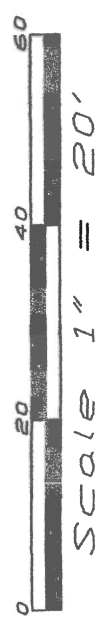

NARRAGANSETT BAY
CRM TYPE 2 WATER
WEST PASSAGE

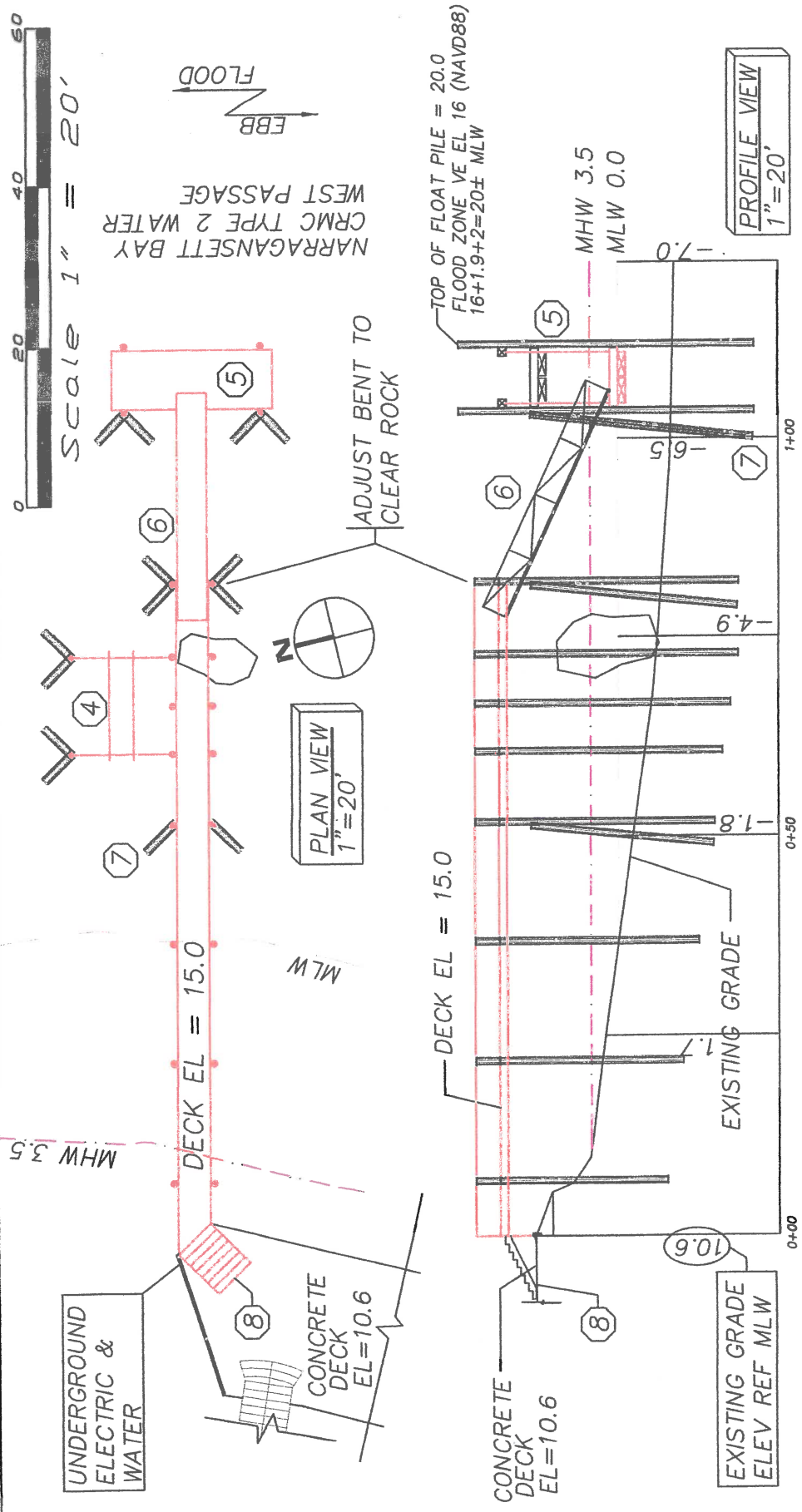
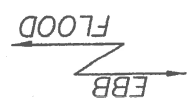

- 4 10,000# BOAT LIFT
- 5 8'x18.75' FLOAT WITH 4 MOTOR LIFT
- 6 3.75'x31' RAMP
- 7 BATTER PILES
- 8 3@3x12 STRINGER FASTEN TO DECK WITH SIMPSON ANCHORS

PROPOSED RESIDENTIAL PIER FOR:
 JONATHAN JANIKIES
 166 WATERWAY
 NARRAGANSETT AP NB, LOT 1
 NORTH KINGSTOWN, AP 1, LOT 148
 BY: WARREN HALL, CIVIL ENGINEER
 DEC. 3, 2018 SHEET 4 OF 10

WARREN HALL

 REGISTERED PROFESSIONAL ENGINEER

CRMC Mailing List for JonJanikies
CRMC File Number 2018-12-037

Jon Janikies
166 Waterway
Saunderstown, RI 02874

Estate of Francis Bayard Rhein
c/o Mrs Francis Bayard Rhein
190 Waterway
Saunderstown, RI 02874

Patricia A. Zangari
164 Waterway
Saunderstown, RI 02874

CRMC (2018-12-037)
O. S. Government Center
4808 Tower Hill Road
Wakefield, RI 02879

Warren Hall, PE
63 Elmwood Avenue
Middletown, RI 02842

Lisa Turner

From: Brittany Spurlock <bspurlock@crmc.ri.gov>
Sent: Thursday, January 17, 2019 11:30 AM
To: rhein@live.com
Cc: Tracy Silvia; Lisa Turner
Subject: Public Notice for 2018-12-037
Attachments: 2018-12-037.pdf

Good Morning Peter,

Please see attachments for the CRMC Public Notice on 166 Waterway Drive, Narragansett (CRMC File - 2018-12-037)

Could you please give us your USPS mailing address so we can add you on to the Public Notice mailing list. Thank you and enjoy your day.

Brittany Spurlock

Data Entry
Coastal Resources Management Council
Oliver Stedman Government Center
4808 Tower Hill Road, Suite 116
Wakefield, RI 02879
(401)783-3370



Virus-free. www.avast.com

From: Lisa Turner <lturner@crmc.ri.gov>
Sent: Wednesday, January 02, 2019 3:22 PM
To: Alison Kates, NRPA Program Coordinator; Amy Rose Weinreich, Charlestown TC; 'Andrew Nota, Jamestown Town Administrator'; 'Bruce Eastman, RISA'; 'C. Brown, DBEngineers'; Carol Wordell Little Compton TC; 'Charlotte Taylor'; Cheryl Fernstrom, Jamestown TC; 'Chris Church, Reporter'; 'Christine Andrews, QDC'; Colin Howard, Independent RI -- South Kingstown; Dale Holberton South Kingstown TC; David Latham; 'David Murdock'; David Prescott, Save the Bay; 'Deborah Mongeau, Librarian'; 'Dennis Erkan, RIDEM F&W'; Donna Giordano, Westerly TC; 'Emilie Holland'; 'Eric Schneider, RIDEM Fish and Wildlife'; Glenn Modica; James Bessette, Editorial Assistant; Jean Bellm, Exec Asst, Barrington; Jeanne Spencer, Tiverton Town Clerk's Office; Jeannette Alyward, North Kingstown TC; 'Jeffrey Gardner'; Jennifer M. West, Portsmouth TC; Jerry Elmer, Esq, CLF; 'John Torgan'; 'John Williams, Warwick Cove Marina'; 'Jonathan F. Stone, Exec Dir'; 'Jude Zeh'; Julie Coelho Warren TC; Kathy & Steve Jacques; Kathy & Steve Jacques; 'Kendra L. Beaver, Esq, Save the Bay'; Kim A. Casci-Palangio, East Prov CC; Laura C. Swistak, City Clerk, Newport; 'Lawrence Taft, Exec Dir'; Leigh Carney, Town Clerk; Liz Boardman; Lori Hagen, Prov City Clerk; Louis P. Cirillo, Bristol Town Clerk; Lyn Pagliarini, Warwick City Clerk; Maria Wall Cranston TC; 'Matt Gineo, Oldport Marine'; Matt O'Brien, AP Reporter; Matthew Enright, Independent RI -- Narragansett; Meg Kerr, Audubon Society of RI; Melanie Jewett Army, AICP, RIDOT; Meredith J. DeSisto, Barrington TC; 'Michael McGiveney'; Mike Jarbeau, Save The Bay; Nancy Mello, Tiverton TC; 'Neal Personius, RIDEM'; Nick Donadio; 'Peter A. Healey'; 'Peter M. Vieira, Marine Construction'; Phil Capaldi; Richard Goldstein Pawtucket TC; 'Richard Kalunian'; 'Robert Lyons, Ocean House Marina'; Rodman R. Black Jr. HIIA; 'Scott Briggs, Librarian'; Taylor Bell (Taylor.M.Bell@usace.army.mil); 'Thomas R. Evans, State Librarian'; 'tim rockwell'; 'Tom Kutcher STB Bay Keeper'; Wendy J. W. Marshall, Middletown TC; Anne Irons, Narragansett TC; Anthony Santilli, Narragansett Building Official; Bryan Couture; Donald Greco; Harvey Cataldo, Bluff Hill Cove Oysters; James Manni, Narr Town Manager; Janice McClanaghan; Jeffrey Ceasrine, PE, Narr Town Engineer; Jill Sabo, AICP, CFM, Town of Narragansett; Michael DiCicco, Director, Narr Public Works; Michael McElroy, Esq.; Michael Vendetti, Chair, BSFD; Narragansett Conservation Commission; Narragansett Times; Patricia Roosa, Narragansett Town Mgrs. Office; Robert Patterson, Narragansett; Scott M. Partington, Fire Chief, Narragansett Fire Dept.; Steve Wright, Narragansett Parks and Recreation; Susan Cicciline-Buonanno, President, Narr Town Council; Thomas J. Dunn Jr., Artisan Builders; Trudy McKendry, HIIA, Secretary; William Onosko
Subject: CRMC Public Notice -- Narragansett
Attachments: 2018-12-037 Janikies Narr.pdf; 2018-11-092 SantaBarbara Narr.pdf

Note: Comments must be received by February 2, 2019

Lisa A. Turner

Office Manager

Coastal Resources Management Council

O S Government Center

4808 Tower Hill Road, Rm 116

Wakefield, RI 02879

(401)783-3370

 **This email is sent on 100% Unused Paper**
Help promote Green Business practices by not printing this email